

EU
xComfort CTAA-0X/03, CTAA-0X/03-LED

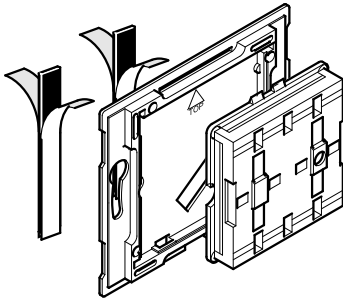

CTAA-01/03
CTAA-01/03-LED

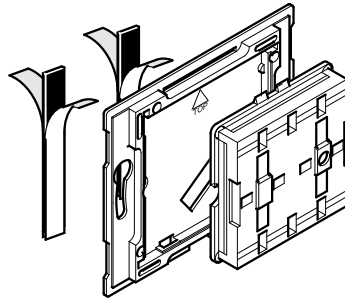

CTAA-02/03
CTAA-02/03-LED

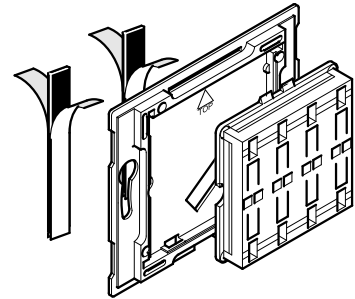

CTAA-04/03
CTAA-04/03-LED

| | | | | | | |
|-----------------------------|------|--|--|--|-------------|-----------------------------------|
| Original Pure Intense | OK ✓ | | | | | MRF EATON Min. Version 1.53 |
| | | | | | | EMC R F Min. Version 3.5 |
| | | | | | | T=-25°C - +70°C T=+5°C - +40°C |
| | | | | | IP20 | |

| | | | | | |
|--|------------|------------|------------|-----------|------------|
| | | | | | |
| | ca. 60-90% | ca. 80-95% | ca. 20-60% | ca. 0-10% | ca. 70-90% |

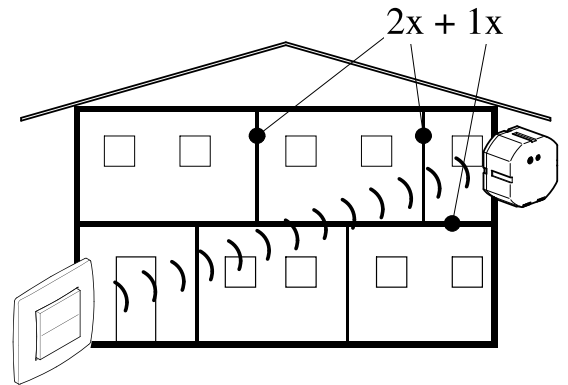
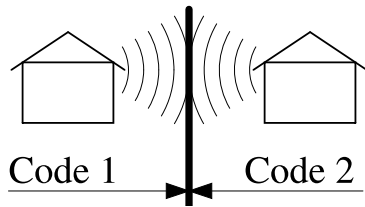
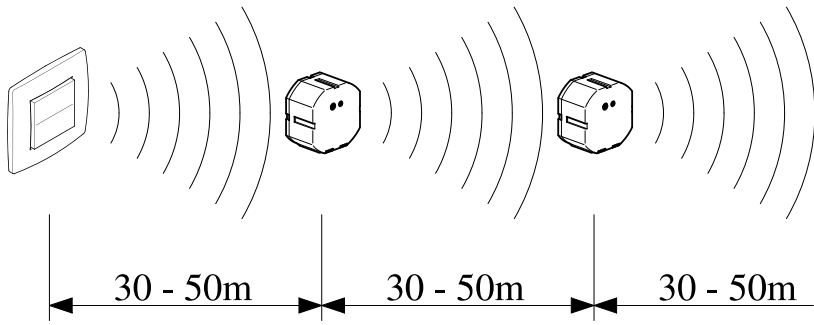

1a

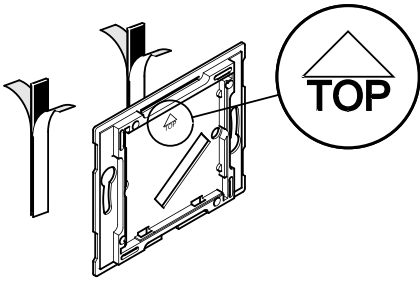

1b

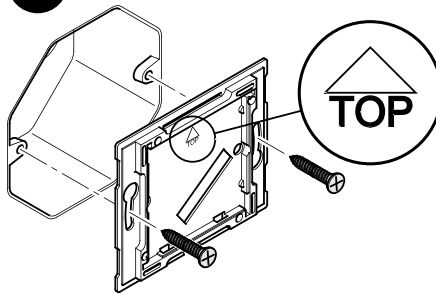

2

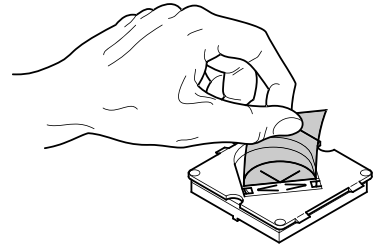

3

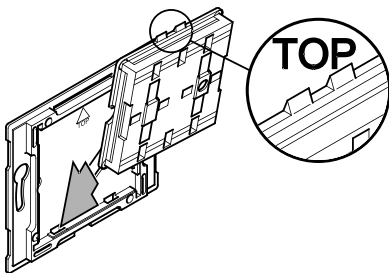

4

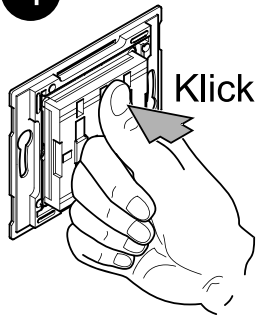

5

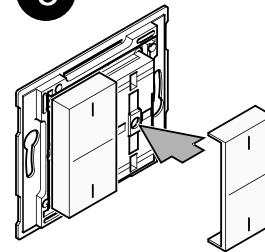

6

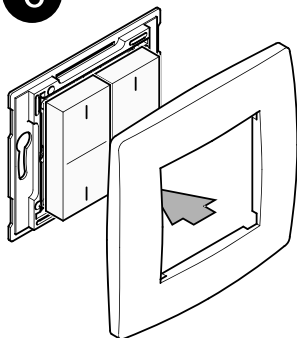

7

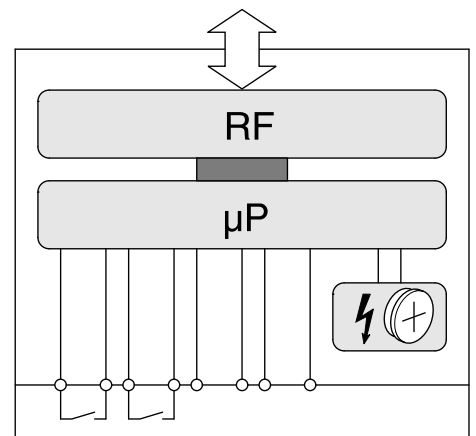
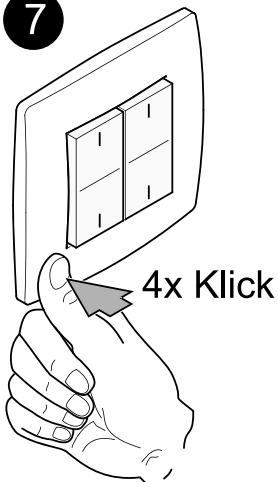

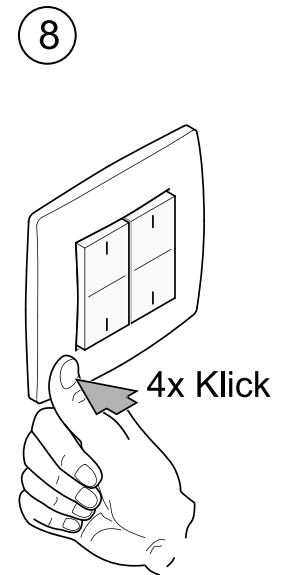
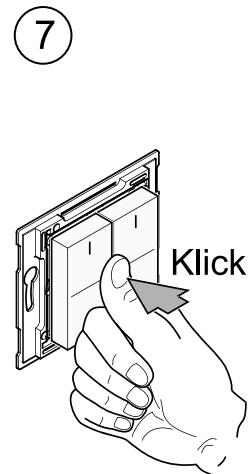
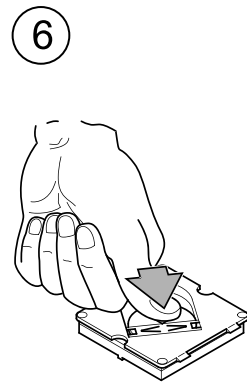
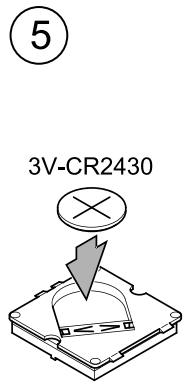
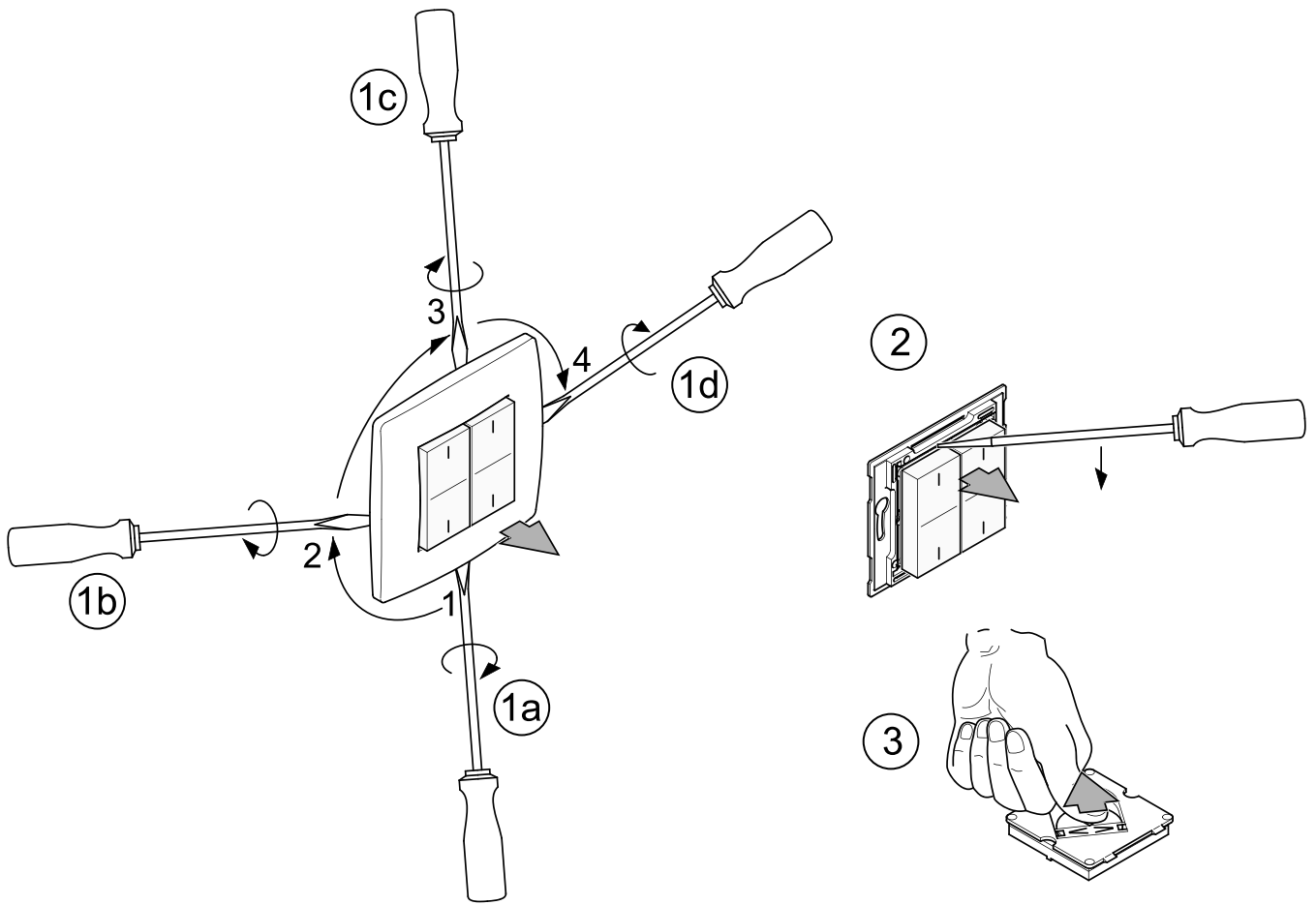

CTAA-0X/03-LED

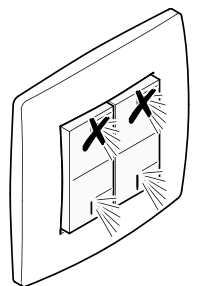
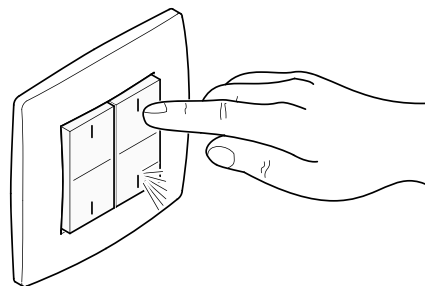
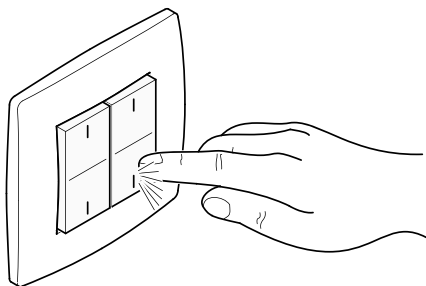



Declaration of Conformity

We, EATON Industries (Austria) GmbH
3943 Schrems, Eugenia 1
Austria

declare under our sole responsibility that the product (family)

Eaton - Push Button,

CTAA-...

(the declaration of conformity applies to all listed types within our actual product catalogue)

provided that it is installed, maintained and used in the application intended for, with respect to the relevant manufacturers instructions, installation standards and "good engineering practices"

complies with the provisions of Council directive(s):

RED Directive 2014/53/EU

RoHS Directive 2011/65/EU

based on compliance with following standard(s):

EN 301489-3 V2.1.1, EN 300220-2 V3.1.1, EN 50491-5-1:2010, EN 50491-5-2:2010, EN 60950-1:2006 + A11:2009 + A1:2010 + A12:2011 + A2:2013, EN 62479:2010, EN 50581:2012



EU- type examination performed by:
TÜV Austria Services GmbH, Notified Body
1230 Vienna, Deutschstrasse 10, Austria

Affixing date of CE mark: 2003
Doc.Id.: CTAA-...171117

Fernando Ceccarelli

Senior Vice President
General Manager

17.11.2017

Friedrich Schröder

Director Quality
& Systems

RF- SYSTEM

BASIC - MODE - CARD

| | | |
|--|---|--|
| <p>CTAA-01/01 CTAA-02/01</p> <p>CBEU-02/01 CBEU-02/02</p> <p>M1 M2 M3 M4 1x 2x 3x 4x</p> <p>CRCA-00/01</p> <p>CHSZ-00/01</p> | <p>CSAU-01/01</p> <p>CJAU-01/01</p> <p>CDAU-01/01</p> | |
|--|---|--|

